

Super-rapid fittings for plastic tubes *Sprint*[®]

Tube external \varnothing 4, 5, 6, 8, 10, 12, 14 mm
 Connections M5, G1/8, G1/4, G3/8, G1/2
 R1/8, R1/4, R3/8, R1/2

Super-rapid fittings are available in 32 different models.
 Connection and disconnection of the tube, can be repeated several times and can be performed using one hand and without the use of tools. The sealing ring (O-ring) can be easily replaced if it is damaged or should the rubber compound from which it is made wear with time.



S6520
 Mod. *Sprint*[®]



- S6510
Mod. *Sprint*[®]
- 6512
- 6463
- 6522
- S6500
Mod. *Sprint*[®]
- 6501
- 6525
Mod. *Sprint*[®]
- S6430
Mod. *Sprint*[®]
- 6432
- S6440
Mod. *Sprint*[®]
- 6442
- S6450
Mod. *Sprint*[®]
6451
- 6622
- 6632
- 6610
- 6620
- 1631
- 6811
Mod. *Sprint*[®]
- 6580
- 6590
- 6550
- 6540
- 6560
- 6600
- 6700
- 6750
- 6900
- 6800
- 6850
- 6950
- 6555
- 6708

FITTINGS

GENERAL DATA

Material	body and collet brass OT58 nickel-plated, O-Ring NBR sealing PTFE/NBR/Nylon
Threads	GAS conical ISO 7 (BSPT) GAS cylindrical ISO 228 (BSP) M5 NPT and metric (available on request)
Pressure	min. -0,8 - max. 16 bar (see tubes)
Tube to connect	Rilsan polyamide 6 - 11 - 12 polyethylene polyurethane
Diameters	ø 4 mm. ÷ ø 14 mm.
Fluid	compressed air (for other types of fluid, contact our engineers)
Temperature	-10°C to +60°C (see data for tubing used)

Fitting with connecting plastic

Sprint®

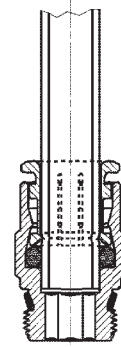

Fittings Mod. S6510...

Mod. *Sprint®*.

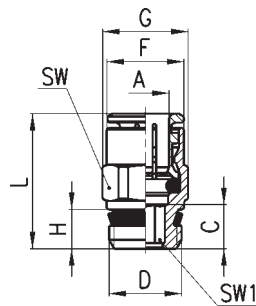

DIMENSIONS

Mod.	A	D	C	F	G	H	L	SW	SW1
S6510 4 - 1/8	4	G1/8	3,8	8,8	13,2	5,5	18	12	2,5
S6510 4 - 1/4	4	G1/4	6	8,8	15,2	7	19,5	14	2,5
S6510 5 - 1/8	5	G1/8	3,8	9,8	13,2	5,5	19	12	3
S6510 5 - 1/4	5	G1/4	5,5	9,8	15,2	7	20	14	3
S6510 6 - 1/8	6	G1/8	6	11,7	13,2	5,5	22	12	4
S6510 6 - 1/4	6	G1/4	5,5	11,7	15,2	7	21	14	4
S6510 8 - 1/8	8	G1/8	7,5	13,7	15,2	5,5	25	14	5
S6510 8 - 1/4	8	G1/4	6,5	13,7	15,2	7	24	14	6
S6510 8 - 3/8	8	G3/8	6,5	13,7	20,5	8	23,5	19	6
S6510 10 - 1/4	10	G1/4	8,5	16,3	18,5	7	28,5	17	7
S6510 10 - 3/8	10	G3/8	5,25	16,3	20,5	8	25,5	19	8
S6510 10 - 1/2	10	G1/2	5	16,3	24,5	9	25	22	8
S6510 12 - 1/4	12	G1/4	10,5	18,3	20,5	7	31,5	19	7
S6510 12 - 3/8	12	G3/8	9,5	18,3	20,5	8	30,5	19	9
S6510 12 - 1/2	12	G1/2	6	18,3	24,5	9	27	22	10
S6510 14 - 3/8	14	G3/8	10,5	21	24,5	8	33,5	22	9
S6510 14 - 1/2	14	G1/2	6,5	21	24,5	9	29,5	22	12

Fittings Mod. 6512...

With O-Ring assembled.

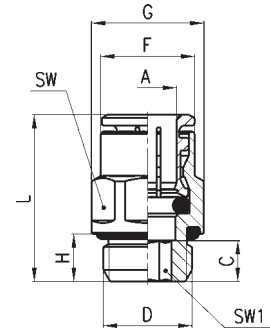

DIMENSIONS

Mod.	A	D	C	F	G	H	L	SW	SW1
6512 4 - M5	4	M5	5,5	7,8	8,8	3,5	19,5	8	2
6512 4 - M6	4	M6	6,5	8,8	9,9	4,5	20,5	9	2,5
6512 4 - 1/8	4	G1/8	5	8,8	13,5	6	19	12	2,5
6512 4 - 1/4	4	G1/4	6,5	8,8	16,4	7	20,5	15	2,5
6512 5 - M5	5	M5	5,5	8,8	9,9	3,5	20,5	9	2
6512 6 - M5	6	M5	5,5	11,7	13,2	3,5	21,5	12	2
6512 6 - 1/8	6	G1/8	5	11,7	13,5	6	21	12	4
6512 6 - 1/4	6	G1/4	6	11,7	16,4	7	22	15	4
6512 8 - 1/8	8	G1/8	8,5	13,7	15,2	6	26	14	5
6512 8 - 1/4	8	G1/4	7	13,7	16,4	7	24,5	15	6
6512 8 - 3/8	8	G3/8	6,5	13,7	20,5	8	24	19	6
6512 10 - 1/4	10	G1/4	10	16,3	18,5	7	30	17	7
6512 10 - 3/8	10	G3/8	5,5	16,3	20,5	8	25,5	19	8
6512 12 - 1/4	12	G1/4	10,5	18,3	20,5	7	31,5	19	7
6512 12 - 3/8	12	G3/8	5,5	18,3	20,5	8	26,5	19	9

Fittings Mod. 6463...

DIMENSIONS								
Mod.	A	D	C	F	G	H	L	SW
6463 4 - M5	4	M5	6,5	8,8	9,9	5	20,5	9
6463 4 - 1/8	4	G1/8	9,5	9	15,2	7,5	23,5	14
6463 5 - 1/8	5	G1/8	10	9,8	15,2	7,5	25	14
6463 6 - 1/8	6	G1/8	9,5	11,7	15,2	7,5	25,5	14
6463 6 - 1/4	6	G1/4	13	11,7	18,5	11	29	17
6463 8 - 1/8	8	G1/8	10	13,7	15,2	7,5	27,5	14
6463 8 - 1/4	8	G1/4	13,5	13,7	18,5	11	31,5	17
6463 10 - 1/4	10	G1/4	13,5	16,3	18,5	11	33,5	17

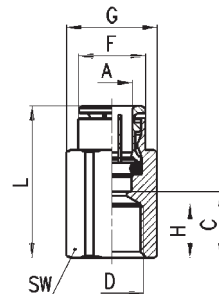

Fittings Mod. S6520...

Swivel elbow Mod. *Sprint*®.

DIMENSIONS										
Mod.	A	D	C	E	F	H	M	SW	SW1	
S6520 4 - 1/8	4	G1/8	6	14,5	10	5,5	20	9	12	
S6520 4 - 1/4	4	G1/4	6	14,5	10	7	20	9	14	
S6520 5 - 1/8	5	G1/8	6	14,5	11	5,5	21	9	12	
S6520 5 - 1/4	5	G1/4	6	14,5	11	7	21	9	14	
S6520 6 - 1/8	6	G1/8	6,5	15	12,7	5,5	22,5	10	12	
S6520 6 - 1/4	6	G1/4	6,5	15	12,7	7	22,5	10	14	
S6520 8 - 1/8	8	G1/8	7,5	16	15	5,5	25	12	12	
S6520 8 - 1/4	8	G1/4	7,5	16	15	7	25	12	14	
S6520 8 - 3/8	8	G3/8	7,5	16,5	15	8	25	12	19	
S6520 10 - 1/4	10	G1/4	8,5	18,5	17,5	7	28,5	14	14	
S6520 10 - 3/8	10	G3/8	8,5	19	17,5	8	28,5	14	19	
S6520 10 - 1/2	10	G1/2	8,5	19,5	17,5	9	28,5	14	22	
S6520 12 - 1/4	12	G1/4	10	20	19,5	7	31	16	17	
S6520 12 - 3/8	12	G3/8	10	20	19,5	8	31	16	19	
S6520 12 - 1/2	12	G1/2	10	20,5	19,5	9	31	16	22	
S6520 14 - 3/8	14	G3/8	12	21	22	8	35	18	19	
S6520 14 - 1/2	14	G1/2	12	21,5	22	9	35	18	22	

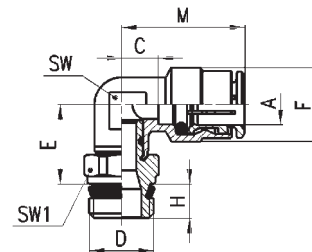

Fittings Mod. 6522...

Swivel elbow with O-Ring assembled.

DIMENSIONS										
Mod.	A	D	C	E	F	H	M	SW	SW1	
6522 4 - M5	4	M5	6	12,5	10	3,5	20	9	8	
6522 4 - 1/8	4	G1/8	6	14,5	10	6	20	9	12	
6522 4 - 1/4	4	G1/4	6	15,5	10	7	20	9	15	
6522 5 - M5	5	M5	6	12,5	11	3,5	21	9	8	
6522 6 - M5	6	M5	6,5	13	12,7	3,5	22,5	10	10	
6522 6 - 1/8	6	G1/8	6,5	15	12,7	6	22,5	10	12	
6522 6 - 1/4	6	G1/4	6,5	16	12,7	7	22,5	10	15	
6522 8 - 1/8	8	G1/8	7,5	16	15	6	25	12	12	
6522 8 - 1/4	8	G1/4	7,5	17	15	7	25	12	15	
6522 8 - 3/8	8	G3/8	7,5	17	15	8	25	12	19	
6522 10 - 1/4	10	G1/4	8,5	19,5	17,5	7	28,5	14	15	
6522 10 - 3/8	10	G3/8	8,5	19,5	17,5	8	28,5	14	19	
6522 12 - 1/4	12	G1/4	10	20	19,5	7	31	16	17	
6522 12 - 3/8	12	G3/8	10	20,5	19,5	8	31	16	19	

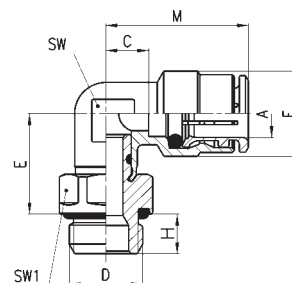

Fittings Mod. S6500..

Mod. *Sprint*[®].

DIMENSIONS

Mod.	A	D	C	E	F	H	M	SW
S6500 4 - 1/8	4	R1/8	6	8,5	10	7,5	20	9
S6500 4 - 1/4	4	R1/4	6	10,5	10	11	20	9
S6500 5 - 1/8	5	R1/8	6	8,5	11	7,5	21	9
S6500 5 - 1/4	5	R1/4	6	10,5	11	11	21	9
S6500 6 - 1/8	6	R1/8	6,5	9	12,7	8,5	22,5	10
S6500 6 - 1/4	6	R1/4	6,5	11,5	12,7	11,5	22,5	10
S6500 8 - 1/8	8	R1/8	7,5	10,5	15	8,5	25	12
S6500 8 - 1/4	8	R1/4	7,5	12	15	11	25	12
S6500 8 - 3/8	8	R3/8	7,5	13	15	11,5	25	12
S6500 10 - 1/4	10	R1/4	7,5	14	17,5	11,5	28,5	14
S6500 10 - 3/8	10	R3/8	7,5	14	17,5	11,5	28,5	14
S6500 12 - 1/4	12	R1/4	10	15,5	19,5	11,5	31	16
S6500 12 - 3/8	12	R3/8	10	15	19,5	11,5	31	16

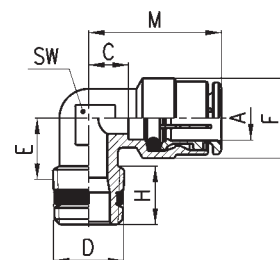

Fitting Mod. 6501 4-M5

With O-Ring assembled.

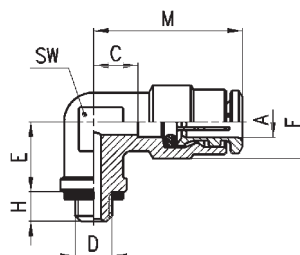

DIMENSIONS

Mod.	A	D	C	E	F	H	M	SW
6501 4 - M5	4	M5	6	10,5	10	4	20	9

Fittings Mod. 6525...

Extended swivel elbow

Sprint[®].

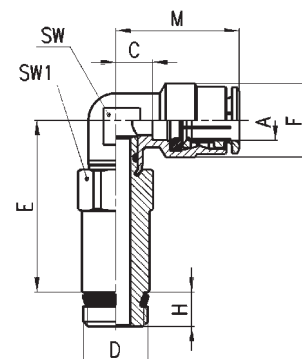

DIMENSIONS

Mod.	A	D	C	E	F	H	M	SW	SW1
6525 6-1/8	6	G1/8	6,5	33,8	12,7	5,5	22,5	10	12
6525 6-1/4	6	G1/4	6,5	34	12,7	7	22,5	10	14
6525 8-1/8	8	G1/8	7,5	34,8	15	5,5	25	12	12
6525 8-1/4	8	G1/4	7,5	35	15	7	25	12	14

Fittings Mod. S6430...

Swivel branch tee, Mod. *Sprint*[®].

DIMENSIONS

Mod.	A	D	C	E	F	H	L	SW	SW1
S6430 4 -1/8	4	G1/8	6	14,5	10	5,5	40	9	12
S6430 5 -1/8	5	G1/8	6	14,5	11	5,5	42	9	12
S6430 5 -1/4	5	G1/4	6	14,5	11	7	42	9	14
S6430 6 -1/8	6	G1/8	6,5	15	12,7	5,5	45	10	12
S6430 6 -1/4	6	G1/4	6,5	15	12,7	7	45	10	14
S6430 8 -1/8	8	G1/8	7,5	16	15	5,5	50	12	12
S6430 8 -1/4	8	G1/4	7,5	16	15	7	50	12	14
S6430 8 -3/8	8	G3/8	7,5	16,5	15	8	50	12	19
S6430 10 -1/4	10	G1/4	8,5	18,5	17,5	7	57	14	14
S6430 10 -3/8	10	G3/8	8,5	19	17,5	8	57	14	19
S6430 12 -1/4	12	G1/4	10	20	19,5	7	62	16	17
S6430 12 -3/8	12	G3/8	10	20	19,5	8	62	16	19
S6430 12 -1/2	12	G1/2	10	20,5	19,5	9	62	16	22
S6430 14 -1/2	14	G1/2	12	21,5	22	9	70	18	22

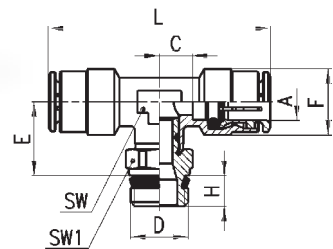

Fittings Mod. 6432...

Swivel branch tee with O-Ring assembled.

DIMENSIONS

Mod.	A	D	C	E	F	H	L	SW	SW1
6432 4 - M5	4	M5	6	12,5	10	3,5	40	9	8
6432 4 - 1/8	4	G1/8	6	14,5	10	6	40	9	12
6432 5 - M5	5	M5	6	12,5	11	3,5	42	9	8
6432 6 - 1/8	6	G1/8	6,5	15	12,7	6	45	10	12
6432 6 - 1/4	6	G1/4	6,5	16	12,7	7	45	10	15
6432 8 - 1/8	8	G1/8	7,5	16	15	6	50	12	12
6432 8 - 1/4	8	G1/4	7,5	17	15	7	50	12	15
6432 8 - 3/8	8	G3/8	7,5	17	15	8	50	12	19
6432 10 - 1/4	10	G1/4	8,5	19,5	17,5	7	57	14	15
6432 10 - 3/8	10	G3/8	8,5	19,5	17,5	8	57	14	19
6432 12 - 1/4	12	G1/4	10	20	19,5	7	62	16	17
6432 12 - 3/8	12	G3/8	10	20,5	19,5	8	62	16	19

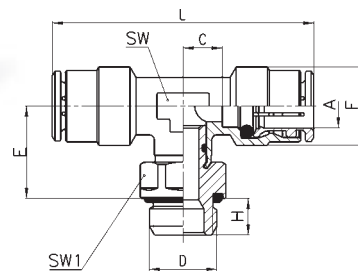

Fittings Mod. S6440...

Mod. *Sprint*[®].

DIMENSIONS

Mod.	A	D	C	E	F	H	L	M	SW	SW1
S6440 4 -1/8	4	G1/8	6	14,5	10	5,5	40	20	9	12
S6440 5 -1/8	5	G1/8	6	14,5	11	5,5	41	21	9	12
S6440 6 -1/8	6	G1/8	6,5	15	12,7	5,5	42,5	22,5	10	12
S6440 6 -1/4	6	G1/4	6,5	15	12,7	7	44	22,5	10	14
S6440 8 -1/8	8	G1/8	7,5	16	15	5,5	46,5	25	12	12
S6440 8 -1/4	8	G1/4	7,5	16	15	7	48	25	12	14
S6440 8 -3/8	8	G3/8	7,5	16,5	15	8	49,5	25	12	19
S6440 10 -1/4	10	G1/4	8,5	18,5	17,5	7	54	28,5	14	14
S6440 10 -3/8	10	G3/8	8,5	18,5	17,5	8	55,5	28,5	14	19
S6440 12 -3/8	12	G3/8	10	19,5	19,5	8	59	31	16	19
S6440 14 -1/2	14	G1/2	12	21,5	22	9	65,5	35	18	22

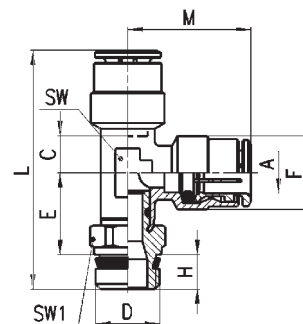

Fittings Mod. 6442...

Swivel run tee with O-Ring assembled.

DIMENSIONS

Mod.	A	D	C	E	F	H	L	M	SW	SW1
6442 4 - M5	4	M5	6	12,5	10	3,5	36	20	9	8
6442 4 - 1/8	4	1/8	6	14,5	10	6	40,5	20	9	12
6442 5 - M5	5	M5	6	12,5	11	3,5	36,5	21	9	8
6442 6 - 1/8	6	1/8	6,5	15	12,7	6	43,5	22,5	10	12
6442 6 - 1/4	6	1/4	6,5	16	12,7	7	45,5	22,5	10	15
6442 8 - 1/8	8	1/8	7,5	16	15	6	47	25	12	12
6442 8 - 1/4	8	1/4	7,5	17	15	7	49	25	12	15
6442 8 - 3/8	8	3/8	7,5	17	15	8	50	25	12	19
6442 10 - 1/4	10	1/4	8,5	19,5	17,5	7	55	28,5	14	15
6442 10 - 3/8	10	3/8	8,5	19,5	17,5	8	56	28,5	14	19
6442 12 - 1/4	12	1/4	10	20	19,5	7	58	31	16	17
6442 12 - 3/8	12	3/8	10	20,5	19,5	8	59,5	31	16	19

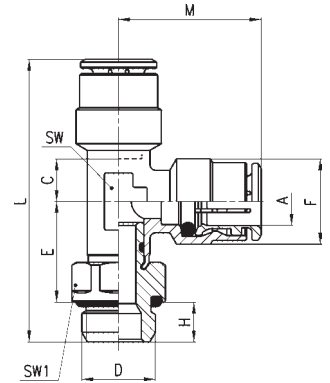

Fittings

Mod. 6451... and Mod. S6450...

Swivel Y connector

* non swivel, with Mod. 2661 assembled.

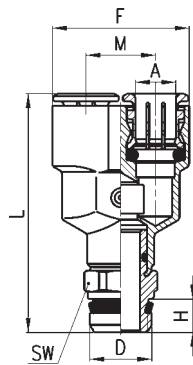

DIMENSIONS

Mod.	A	D	F	H	L	M	SW
6451 4-M5	4	M5	18	4	26,5	9	*
6451 6-M5	6	M5	24,5	4	29,5	12,5	*
S6450 4-1/8	4	G1/8	18	5,5	38	9	12
S6450 6-1/8	6	G1/8	24,5	5,5	41,5	12,5	12
S6450 8-1/8	8	G1/8	28,5	5,5	48,5	14,5	14
S6450 8-1/4	8	G1/4	28,5	7	50	14,5	14

Fittings

Mod. 6622...

Banjo with O-Ring assembled.

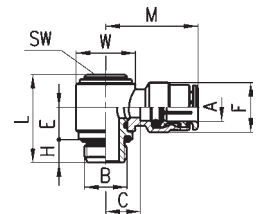

DIMENSIONS

Mod.	A	B	C	E	F	H	L	M	W	SW
6622 4 - M5	4	M5	4	6	8,8	3,5	16	18,5	□9	2,5
6622 4 - 1/8	4	G1/8	8,5	10	22,5	6	26	14	Ø14	4
6622 6 - 1/8	6	G1/8	8,5	10	12,7	6	26	24,5	Ø14	4
6622 6 - 1/4	6	G1/4	10,5	10	12,7	7	27	26,5	Ø18	5
6622 8 - 1/8	8	G1/8	8,5	10	15	6	26	26	Ø14	4
6622 8 - 1/4	8	G1/4	10,5	10	15	7	27	28	Ø18	5
6622 10-1/4	10	G1/4	10	10	17,5	7	27	30	Ø18	5

Fittings Mod. 6632...

Banjo with O-Ring assembled.

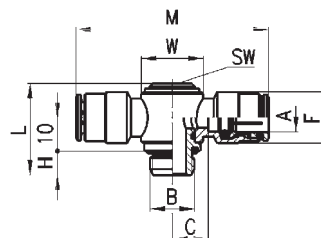

DIMENSIONS

Mod.	A	B	C	F	H	L	M	W	SW
6632 4 -1/8	4	G1/8	8,5	10	6	26	45	Ø14	4
6632 6 -1/8	6	G1/8	8,5	12,7	6	26	49	Ø14	4
6632 6 -1/4	6	G1/4	10,5	12,7	7	27	53	Ø18	5
6632 8 -1/8	8	G1/8	8,5	15	6	26	52	Ø14	4
6632 8 -1/4	8	G1/4	10,5	15	7	27	56	Ø18	5
6632 10 -1/4	10	G1/4	10	17,5	7	27	60	Ø18	5

Fittings Mod. 6610...

- * Assembly required with Mod. 1635
- assembly possible only with Mod. SCU, SVU, SCO... M5.

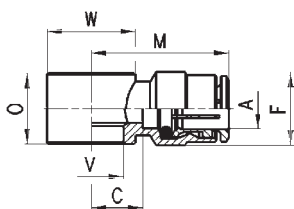

DIMENSIONS

Mod.	A	C	F	M	O	V	W
6610 4 - M5	4	5	9	19	9	5,1	□9
6610 4 - M6	4	5	9	19	9	5,1	□9 •
6610 4 -1/8	4	8,5	10	22,5	14,5	9,8	Ø14
6610 5 - M5	5	5	10	20	9	5,1	□9
6610 5 - M6	5	5	10	20	9	5,1	□9 •
6610 5 -1/8	5	8,5	11	23,5	14,5	9,8	Ø14
6610 6 - M5	6	6,5	12,7	22,5	9	5,1	Ø10
6610 6 - M6	6	6,5	12,7	22,5	9	5,1	Ø10 •
6610 6 -1/8	6	8,5	12,7	24,5	14,5	9,8	Ø14
6610 6 -1/4	6	10,5	12,7	26,5	14,5	13,2	Ø18
6610 8 -1/8	8	8,5	15	26	14,5	9,8	Ø14
6610 8 -1/4	8	10,5	15	28	14,5	13,2	Ø18
6610 8 -3/8	8	11,5	15	29	14,5	16,7	Ø21
6610 10 -1/4	10	10	17,5	30	14,5	13,2	Ø18 *
6610 10 -3/8	10	11,5	17,5	31,5	14,5	16,7	Ø21 *
6610 12 -1/2	12	14	19,5	35	14,5	21	Ø26 *

Fittings Mod. 6620...

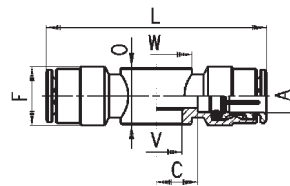

DIMENSIONS

Mod.	A	C	F	L	O	V	W
6620 4 - M5	4	5	9	38	9	5,1	□9
6620 4 -1/8	4	8,5	10	45	14,5	9,8	Ø14
6620 6 -1/8	6	8,5	12,7	49	14,5	9,8	Ø14
6620 6 -1/4	6	10,5	12,7	53	14,5	13,2	Ø18
6620 8 -1/8	8	8,5	15	52	14,5	9,8	Ø14
6620 8 -1/4	8	10,5	15	56	14,5	13,2	Ø18

Fittings Mod. 1631....

The dimensions of the banjo bolts, Mod. 1631-01, Mod. 1631-02 and Mod. 1631-03 are given on page 7.04.010 and 7.04.011.



Mod.

1631-01

1631-02

1631-03

Fittings Mod. 6811...

Mod. *Sprint*[®]

* with O-Ring assembled.

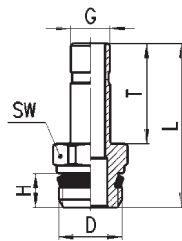

DIMENSIONS

Mod.	G	D	H	T	L	SW
6811 4 - M5	4	M5	3,5	16,5	24	8 *
6811 4 - 1/8	4	G1/8	5,5	16,5	27,8	12
6811 5 - 1/8	5	G1/8	5,5	18	29,3	12
6811 5 - 1/4	5	G1/4	7	18	31	14
6811 6 - 1/8	6	G1/8	5,5	18	29,3	12
6811 6 - 1/4	6	G1/4	7	18	31	14
6811 8 - 1/8	8	G1/8	5,5	20,5	31,8	12
6811 8 - 1/4	8	G1/4	7	20,5	33,5	14
6811 10 - 1/4	10	G1/4	7	23	36	14
6811 10 - 3/8	10	G3/8	8	23	37,3	19
6811 12 - 3/8	12	G3/8	8	24	38,3	19
6811 14 - 1/2	14	G1/2	9	28	44	22

Fittings Mod. 6580...

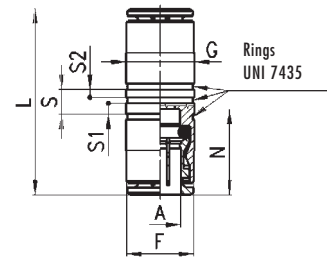

DIMENSIONS

Mod.	A	F	G	L	N	S	S1	S2
6580 4	4	8,8	10	30	14	5	2,2	1,6
6580 5	5	9,8	11	33	14,5	5	2,2	1,6
6580 6	6	11,7	12	34	16	5	2,2	1,6
6580 8	8	13,7	14	38	17,5	5	2,2	1,6
6580 10	10	16,3	17	42,5	20	5	2,2	1,6
6580 12	12	18,3	19	44,5	21	5,2	2,2	1,6
6580 14	14	21	22	48	23	5,2	2,2	1,6

Fittings Mod. 6590...

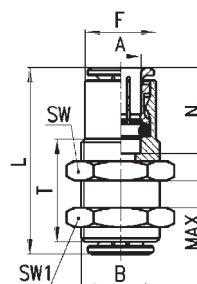

DIMENSIONS

Mod.	A	B	F	L	N	MAX	SW	SW1	T
6590 4	4	M10 x 1	8,6	30	14	10,5	14	14	20
6590 5	5	M12 x 1	9,8	33	14,5	10,5	17	17	20
6590 6	6	M14 x 1	12,5	34	16	10,5	17	17	20
6590 8	8	M16 x 1	14,5	38	17,5	11,5	19	19	21
6590 10	8	M18 x 1	16,3	42,5	20	13	22	22	23,5
6590 12	12	M20 x 1	18,3	44,5	21	14,5	24	24	25
6590 14	14	M22 x 1	20,5	48	23	17,5	27	27	30

Fittings Mod. 6550...

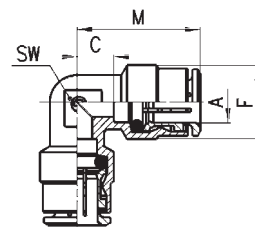

DIMENSIONS

Mod.	A	C	F	M	SW
6550 4	4	6	10	20	9
6550 5	5	6	11	21	9
6550 6	6	6,5	12,7	22,5	10
6550 8	8	7,5	15	25	12
6550 10	10	8,5	17,5	28,5	14
6550 12	12	10	19,5	31	17
6550 14	14	12	22	35	19

Fittings Mod. 6540...

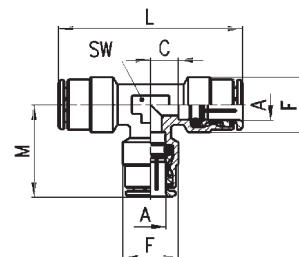

DIMENSIONS

Mod.	A	C	F	L	M	SW
6540 4	4	6	10	40	20	9
6540 5	5	6	11	42	21	9
6540 6	6	6,5	12,7	45	22,5	10
6540 8	8	7,5	15	50	25	12
6540 10	10	8,5	17,5	57	28,5	14
6540 12	12	10	19,5	62	31	17
6540 14	14	12	22	70	35	19

Fittings Mod. 6560...

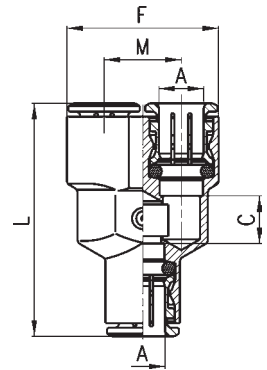

DIMENSIONS

Mod.	A	C	F	L	M
6560 4	4	5	18	33	9
6560 6	6	7	24,5	39	12,5
6560 8	8	9	28,5	44	14,5
6560 10	10	15,5	32	53,5	16

Fittings Mod. 6600...

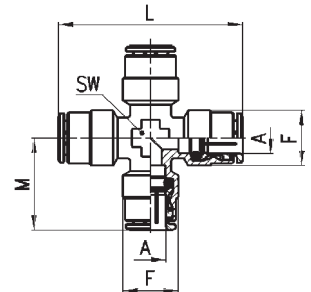

DIMENSIONS

Mod.	A	F	L	M	SW
6600 4	4	10	40	20	9
6600 5	5	11	42	21	9
6600 6	6	12,7	45	22,5	10
6600 8	8	15	50	25	12
6600 10	10	17,5	57	28,5	14
6600 12	12	19,5	62	31	16

Fittings Mod. 6700...

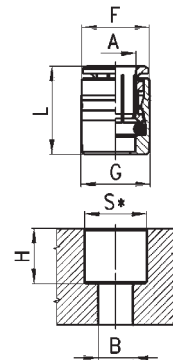

DIMENSIONS

Mod.	A	F	G	L	Size	S	H	B
6700 4	4	8,6	9	14,5	4	8,75	11	3,5
6700 5	5	9,6	10	15,5	5	9,75	11,5	3,5
6700 6	6	11,8	12,2	16,5	6	11,95	12	4
6700 8	8	13,8	14,2	18	8	13,95	14	6
6700 10	10	15,8	16,2	20,5	10	15,95	16,5	8

*Metallic seat +0.05 / 0

*Synthetic seat +0.03 / -0.02

Fittings Mod. 6750...

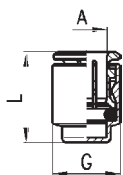

DIMENSIONS

Mod.	A	G	L
6750 4	4	8,8	15
6750 6	6	11,8	17
6750 8	8	13,8	18,5
6750 10	10	15,8	21
6750 12	12	17,8	22

Fittings Mod. 6900...



Plastic

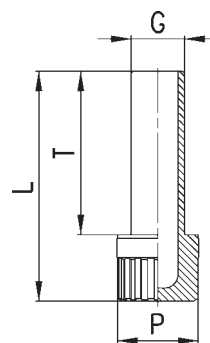

DIMENSIONS

Mod.	G	L	P	T
6900 4	4	29	8	20
6900 5	5	29,5	8	20,5
6900 6	6	31,5	8	22,5
6900 8	8	34,5	12	24,5
6900 10	10	37	12	27
6900 12	12	40,5	16	28,5
6900 14	14	42,5	16	30,5

Fittings Mod. 6800...

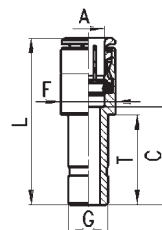

DIMENSIONS

Mod.	A	G	C	F	L	T
6800 4 - 5	4	5	20	10	34	18
6800 4 - 6	4	6	20	10	34	18
6800 4 - 8	4	8	19	10	33	20,5
6800 5 - 6	5	6	20	11	35	18
6800 5 - 8	5	8	19	11	34	20,5
6800 6 - 8	6	8	22,5	13	38,5	20,5
6800 6 - 10	6	10	21	13	36,5	23
6800 6 - 12	6	12	22	13	37,5	24
6800 8 - 10	8	10	25	14	42,5	23
6800 8 - 12	8	12	22,5	14	40	24
6800 10 - 12	10	12	25,5	17	45,5	24
6800 10 - 14	10	14	25,5	17	45,5	28
6800 12 - 14	12	14	30	18,8	51	28

Fittings Mod. 6850...

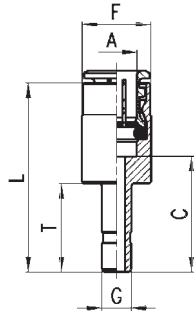

DIMENSIONS

Mod.	A	G	C	F	L	T
6850 6 - 4	6	4	19	13	34,5	16,5
6850 8 - 6	8	6	23,5	14	41	18

Fittings Mod. 6950...

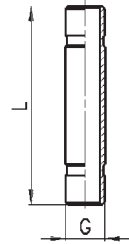

DIMENSIONS

Mod.	G	L
6950 4	4	32,5
6950 6	6	35,5
6950 8	8	40,5
6950 10	10	46
6950 12	12	48
6950 14	14	52

Fittings Mod. 6555...

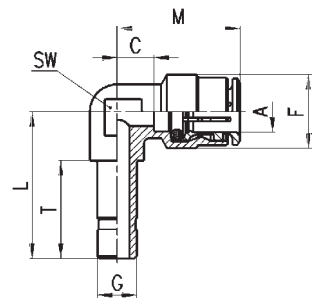

DIMENSIONS

Mod.	A	G	C	L	F	T	M	SW
6555 4 - 4	4	4	6	24	10	16,5	20	9
6555 6 - 6	6	6	6,5	26	12,7	18	22,5	10
6555 8 - 8	8	8	7,5	30	15	20	25	12
6555 10-10	10	10	8,5	33,5	17,5	23	28,5	14

Fittings Mod. 6708...

DIMENSIONS

Mod.	A	F	L
6708 4	4	10,7	10
6708 5	5	11,7	10,5
6708 6	6	13,7	11
6708 8	8	15,7	12
6708 10	10	18,5	12,5
6708 12	12	20,7	14,5
6708 14	14	23,7	14,5

Self-extinguishing material
colour black
V0

